

1 **BRAVILOR BONAMAT**

Thermal Brewer Aurora

TR Kullanıcı kılavuzu

RU Руководство пользователя

KO 사용 설명서



digital 759F (TR RU KO)

GTBSH-001

GTBSH-002

GTBSH-003

GTBSH-004

GTBTH-001

GTBTH-002

GTBTH-003

GTBTH-004

GTBSL-001

GTBSL-002

GTBSL-003

GTBSL-004

GTBSH-005

GTBTL-001

GTBTL-002

GTBTL-003

GTBTL-004



Türkçe
Русский
한국어



Bilgiler
Информация
정보



İçindekiler
Содержание
목차



Güvenlik kitabı
Руководство по безопасности
안전 지침서



Kullanım
Порядок работы
취급



Seçim
Выбор
선택



AÇMA/KAPAMA anahtarı
Вкл/выкл выключатель
켜기/끄기 스위치



Temizlik
Очистка
세척



Konteyner
Контейнер
컨테이너



Tabansız konteyner
Контейнер без основания
받침대 없는 상태의 컨 테이너



Teneke Kutu
Банка
캔



Hava Deposu
Помповый термос
에어포트



Su
Вода
물



Konteyner seç
Выбор контейнера
컨테이너 선택



Tarif seç
Выбор рецепта
레시피 선택



Hacim seç
Выбор объема
양 선택



Demleme
Варка
끓이기



Sinyal
Сигнал
신호



Bekle
Подждать
기다리십시오



Demlemeyi durdur
Остановить варку
끓이기 중지



Sıcak sıvı
Горячая жидкость
뜨거운 음료



Filtre karteri
Фильтр
필터 팬



Püskürtme başlığı
Распыляющая головка
스프레이 헤드



Fırça
Щетка
브러시



Türkçe
Русский
한국어



Düğme
Монета
코인



Nem bezi
Влажная ткань
젖은 천



Durula
Промывка
헹구기



Deterjan
Чистящее средство
세제



Bulaşık makinesinde yıkanabilir
Можно мыть в посудомоечной машине
싱기 세척기에 세척 가능



Programlama
Программирование
프로그래밍



Mesajlar
Сообщения
메시지



Tedarikçiyi ara
Свяжитесь с поставщиком
공급업체에 전화



MENÜ düğmesine bas
Нажмите МЕНЮ
MENU(메뉴) 누르기



Nem bezi
Влажная ткань
천 적시기



HACİM düğmesine bas
Нажмите ОБЪЕМ
VOLUME(양) 누르기



SOL/SAĞ düğmesine bas
Нажмите ВЛЕВО/ВПРАВО
LEFT/RIGHT(좌/우) 누르기



SOL/SAĞ düğmesini basılı tut
Удерживайте ВЛЕВО/ВПРАВО
LEFT/RIGHT(좌/우) 누르고



BAŞLAT/DURDUR düğmesine bas
Нажмите НАЧАТЬ/ОСТАНОВИТЬ
START/STOP(시작/정지) 누르기



Otomatik işlem
Автоматическая работа
자동 처리

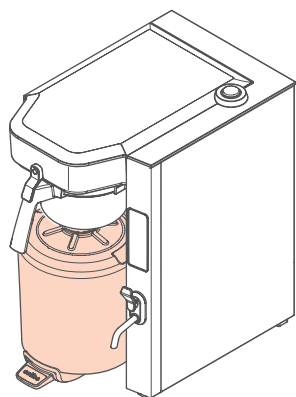

Aurora Single Low

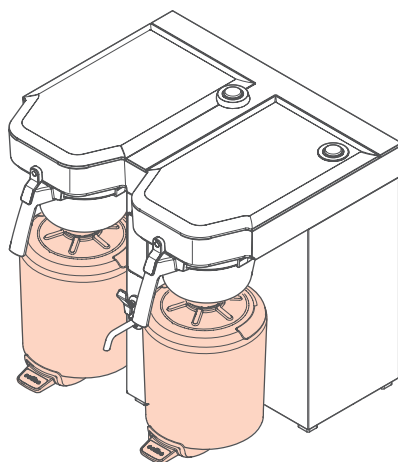

Aurora Twin Low

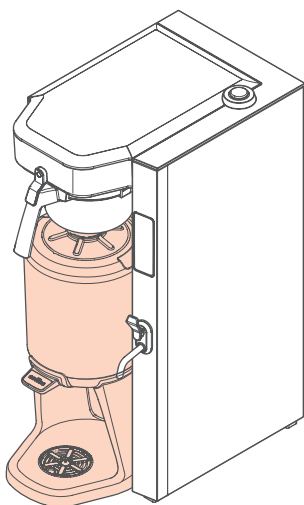

Aurora Single High

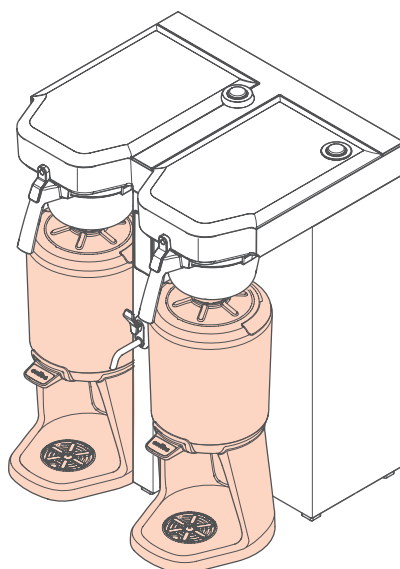

Aurora Twin High

**TR**















Lütfen ekteki Güvenlik Kılavuzunu dikkatlice okuyun. Güvenlik Kılavuzu eksikse, lütfen www.bravilor.com adresini ziyaret edin.
Halihazırda ekte olan Kullanıcı Kılavuzu (bölüm 2) Kurulum, Kireç Çözme ve Programlama bölümlerini içerir.

RU

Внимательно прочитайте прилагаемое руководство по технике безопасности. Если это руководство в комплект не входит, то обратитесь на сайт www.bravilor.com.
В руководстве пользователя (часть 2), который также входит в комплект, содержатся разделы, посвященные установке, удалению накипи и программированию.

KO

제품과 함께 제공되는 안전 지침서를 꼼꼼하게 읽어보십시오. 안전 지침서가 누락된 경우 www.bravilor.com을 이용하십시오.
함께 제공되는 사용자 설명서(2부)는 설치, 물때 제거, 프로그래밍 장으로 구성되어 있습니다.

	_____	9
  	_____	10
 	_____	13
  	_____	14
	_____	15
 	_____	16
 	_____	17
P	_____	19
E	_____	33
E 	_____	34

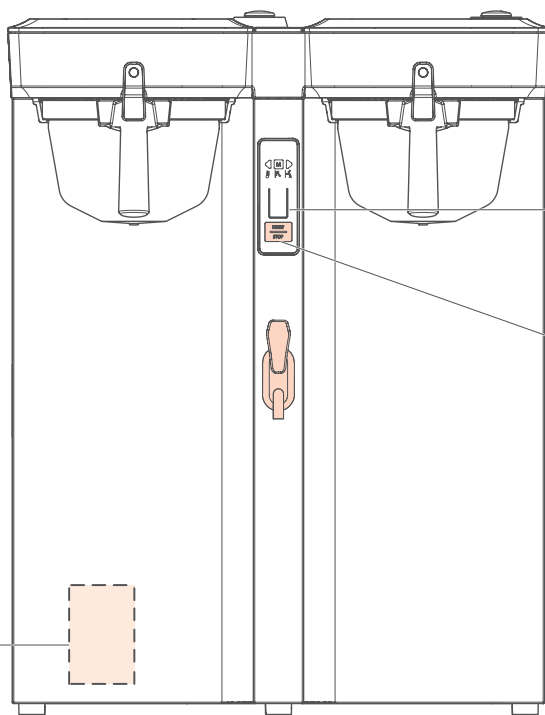
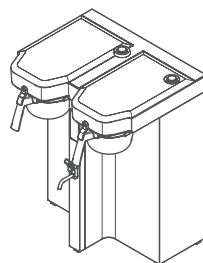
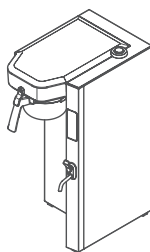
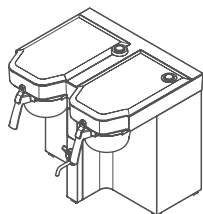
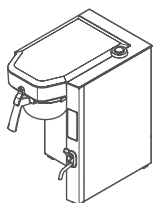

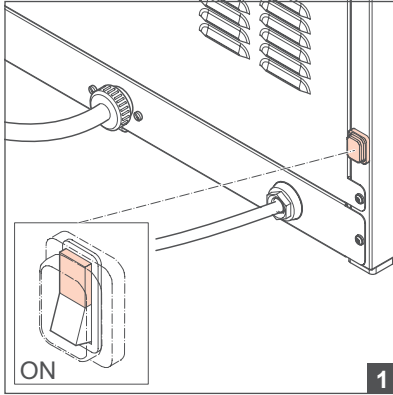

TR ısıtma
RU нагрев
KO 가열 중

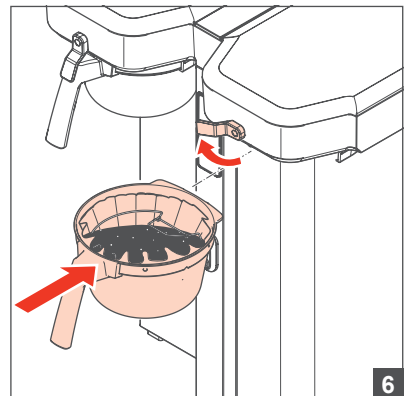
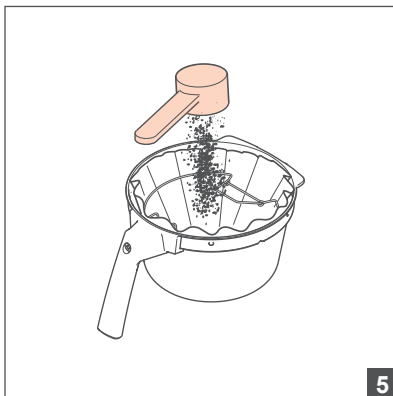
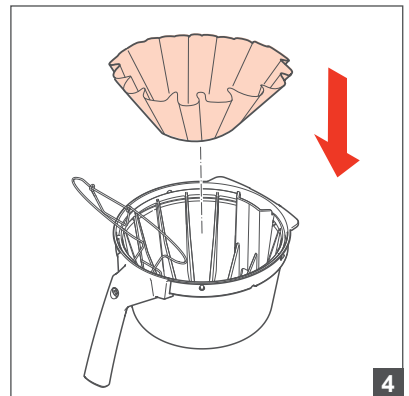
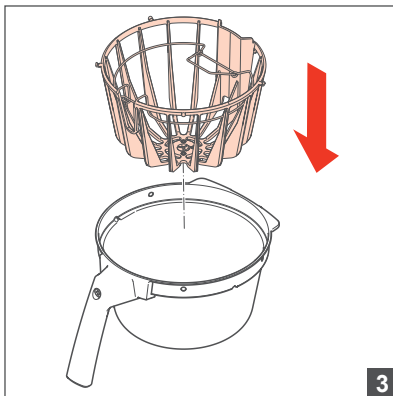
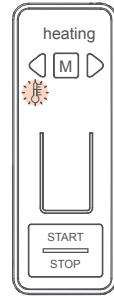

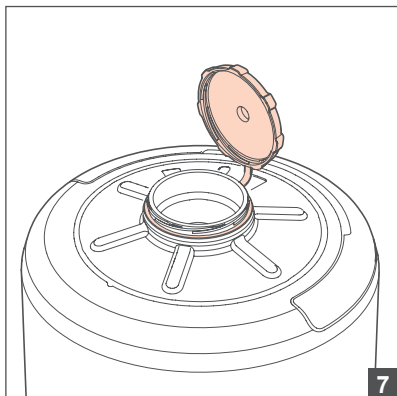

7

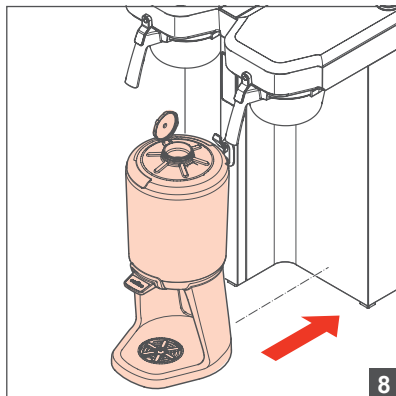

8



- TR ## litre "tarif x"
- RU ## литров «рецепт x»
- KO ## 리터 "레시피 x"

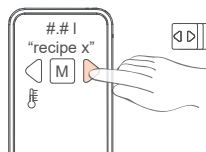
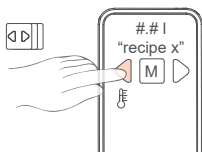
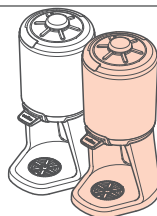
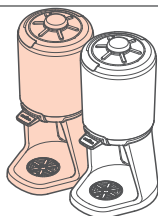

9



- TR ## litre "tarif x/y/z"
- RU ## литров «рецепт x/y/z»
- KO ## 리터 "레시피 x/y/z"

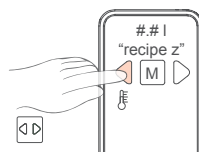
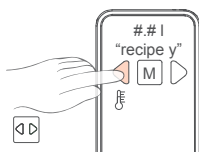
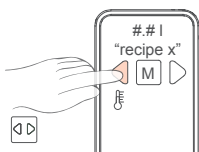
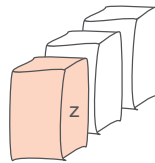
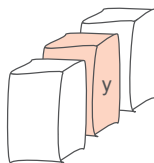
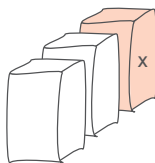

10



TR ## litre
"tarif x"
RU ## литров
«рецепт x»
KO ## 리터
레시피 x"

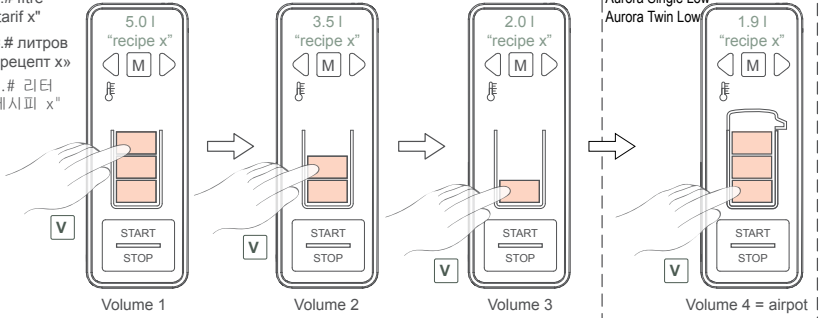

11



TR ## litre/demleme
"tarif x"
RU ## литров/заваривания
«рецепт x»
KO ## 리터/양조
"레시피 x"

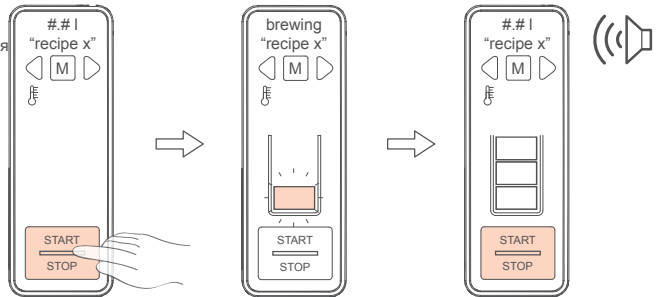

12

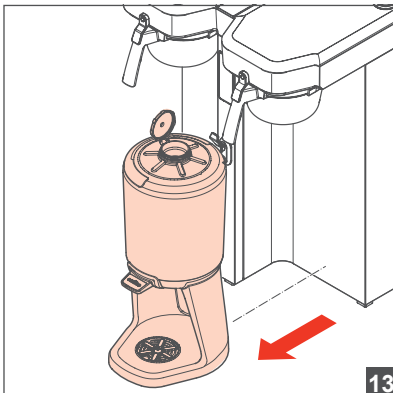

13



- TR demleme iptal edildi
- RU варка остановлена
- KO 끓이가 취소됨

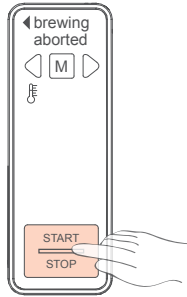

1

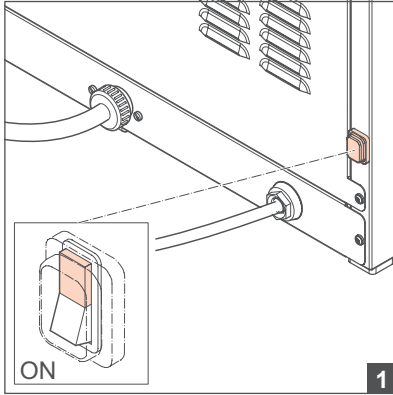

TR istma

RU harpes

KO 가열 앰

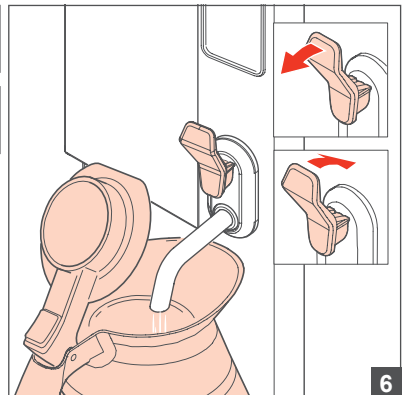
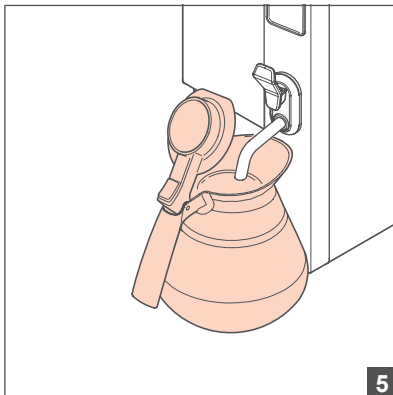
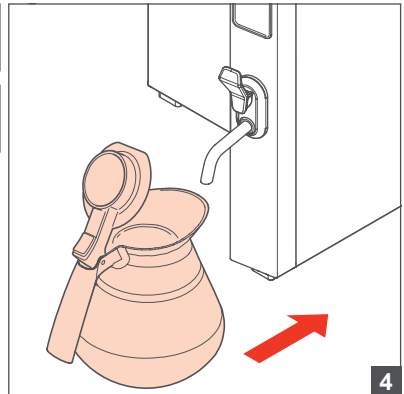
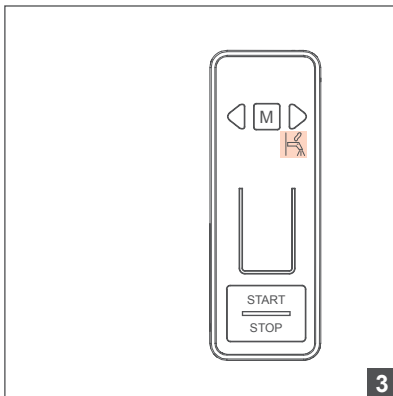
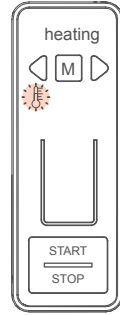

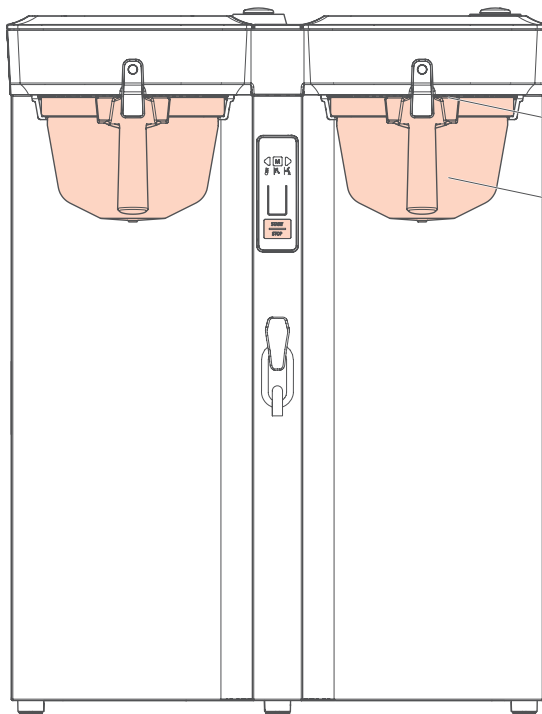
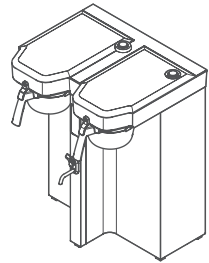
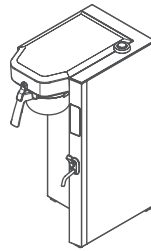
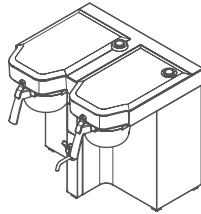
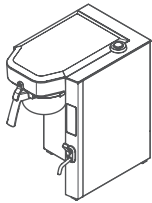

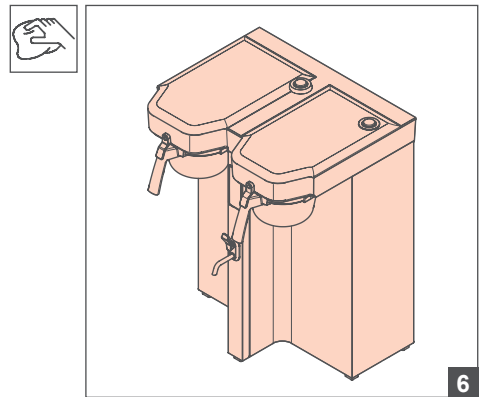
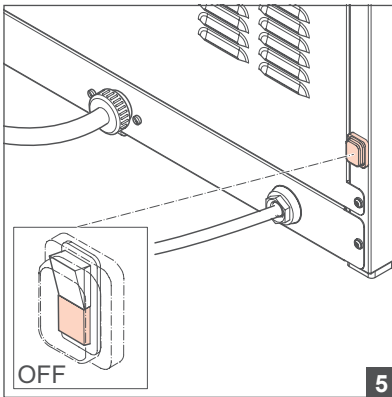
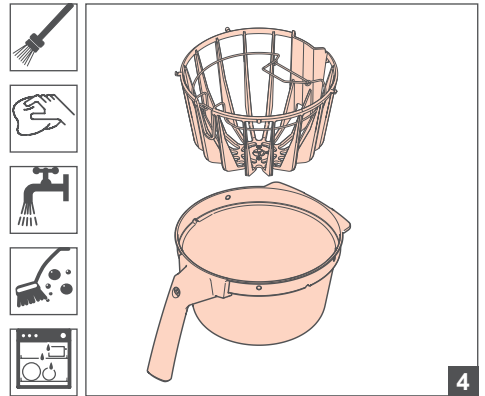
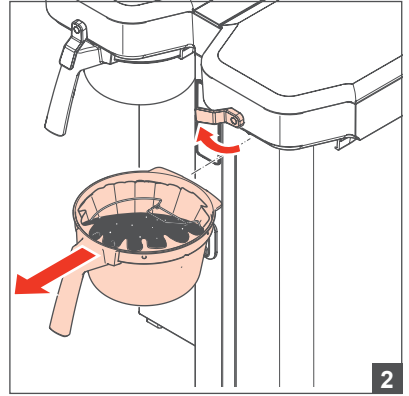
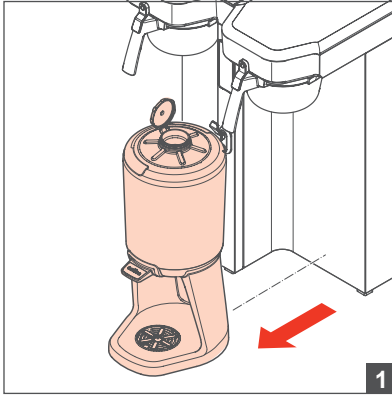

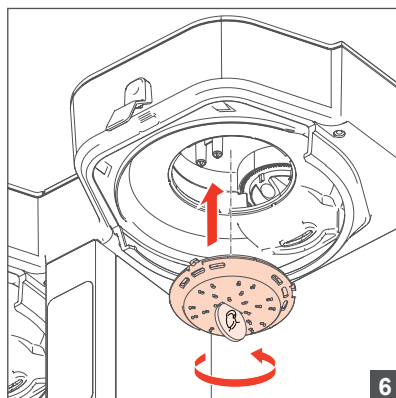
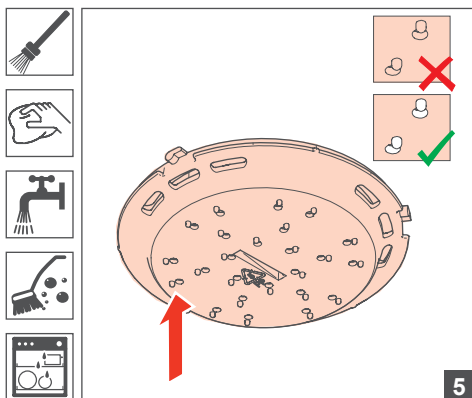
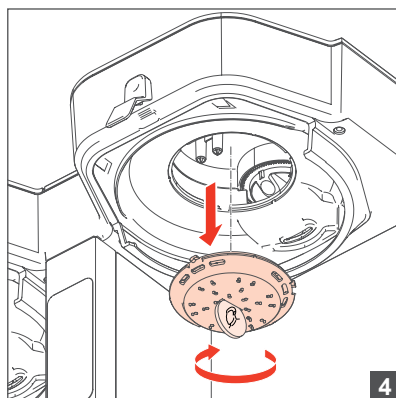
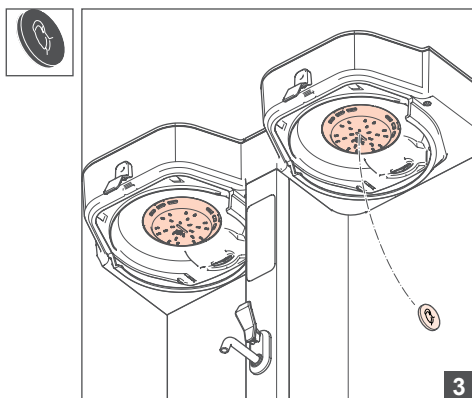
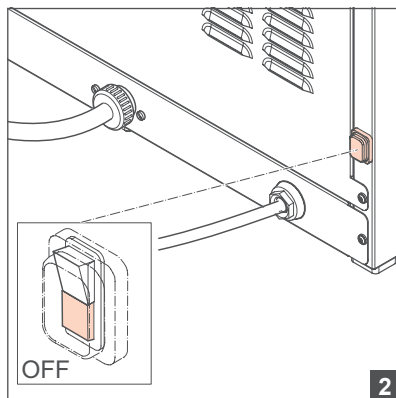
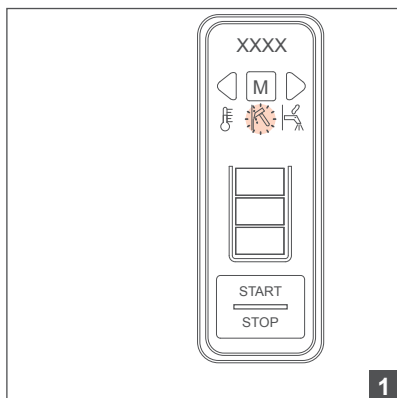

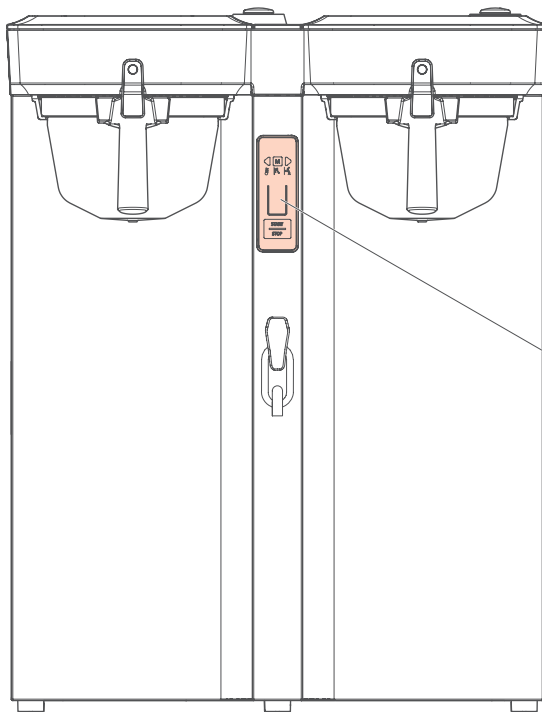
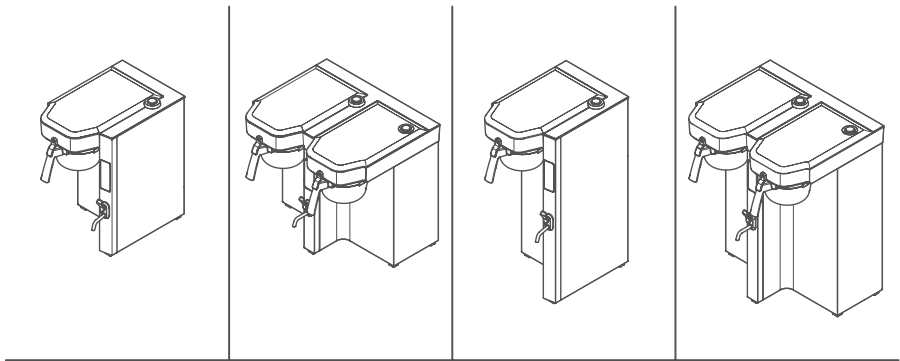

P

EKRAN

Ekran, düğmeler ve bir metin penceresi ile makine ile iletişim kurulmasına yardımcı olur.

Metin penceresi

Metin penceresi (1) şunları gösterebilir:

- menüler
- menüdeki öğeler
- ayarlar
- komutlar
- otomatik prosedürler

İkili bir makineye sahipseniz, siyah ok (2), sol demleyiciyi mi yoksa sağ demleyiciyi mi çalıştırdığınızı gösterir.

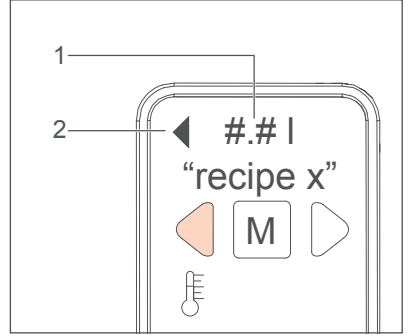
**Düğmeler**

Düğmeler ile makinenin menüleri arasında gezinebilirsiniz.

1. MENÜ düğmesi
2. SOL/SAĞ düğmesi
3. HACİM düğmesi
4. BAŞLAT/DURDUR

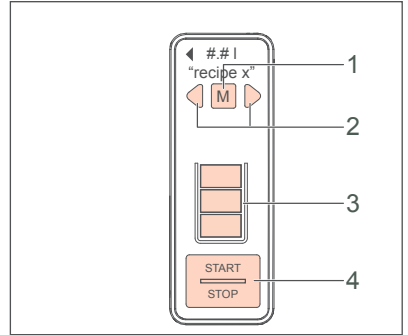
**Menüler**

Temel çalıştırma, şunlara ait menülere sahiptir:

- tarifin seçimi
- demleyeceğiniz kahvenin miktarının nasıl değiştirileceği
- makineyi başlatma veya durdurma

Kullanıcı menülerinde tercihlerinizi tanımlayabilirsiniz. Menülerde şunları yapabilirsiniz:

- tarifler oluşturma, değiştirme, indirme ya da yükleme
- sıcaklık, takvim, saat, makinelerin ayarını değiştirme
- aşağıdakiler gibi makine programlarının ayarını değiştirme:
 - Eko
 - Su filtresi
 - Kireç çözme
 - Temizlik

Navigasyon

Navigasyon için düğmelere dokununuz.

Bu kılavuzda iki farklı yolda düğme dokunuşu tanımlanmıştır:

- Bir düğmeye basın: düğmeye kısa süreli dokununuz.
- Bir düğmeyi basılı tutun: düğmeye en az 1 saniye süresince dokununuz.

Bir düğmeye dokunmanın farklı yollarından her biri, ekran navigasyonunda farklı bir işlem ile sonuçlanır.

Düğme Komutları

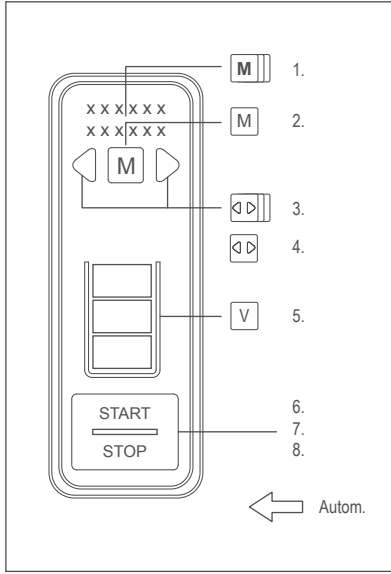

1. Menü düzeyinde bir seçimi onaylamak için MENÜ düğmesini 1 saniye basılı tutun.
2. Sonraki menü düzeyine ilerlemek için MENÜ düğmesine kısa süreli basın.
3. Demleyicide geçiş yapmak için (yalnızca İKİLİ versiyonda) SOL/SAĞ düğmesine basın.
4. Menü düzeyi seçenekleri arasında geçiş yapmak için SOL/SAĞ düğmesine kısa süreli basın.
5. Demlediğiniz hacmi değiştirmek için HACİM düğmesine kısa süreli basın.
6. Demlemeyi başlatmak için BAŞLAT/DURDUR düğmesine basın.
7. Demleme işlemini iptal etmek için BAŞLAT/DURDUR düğmesini basılı tutun ya da düğmesine basın.
8. Bir menü düzeyi geri gitmek için BAŞLAT/DURDUR düğmesine kısa süreli basın.

Otomatik prosedürler

Şemadaki beyaz oklar, makinenin gerçekleştirdiği otomatik prosedürleri gösterir.

TR

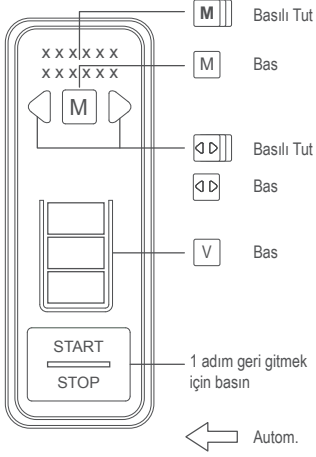

- İkili versiyonlar
- İsteğe bağlı veya yalnızca düşük versiyonlar için
- ” xx ” Sabit değer
- [xx] Bu değeri değiştirebilirsiniz

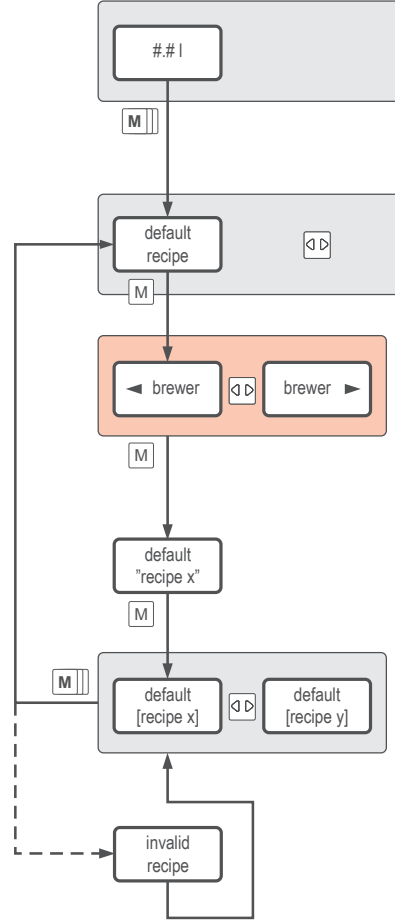

1 Kullanıcı menüsü

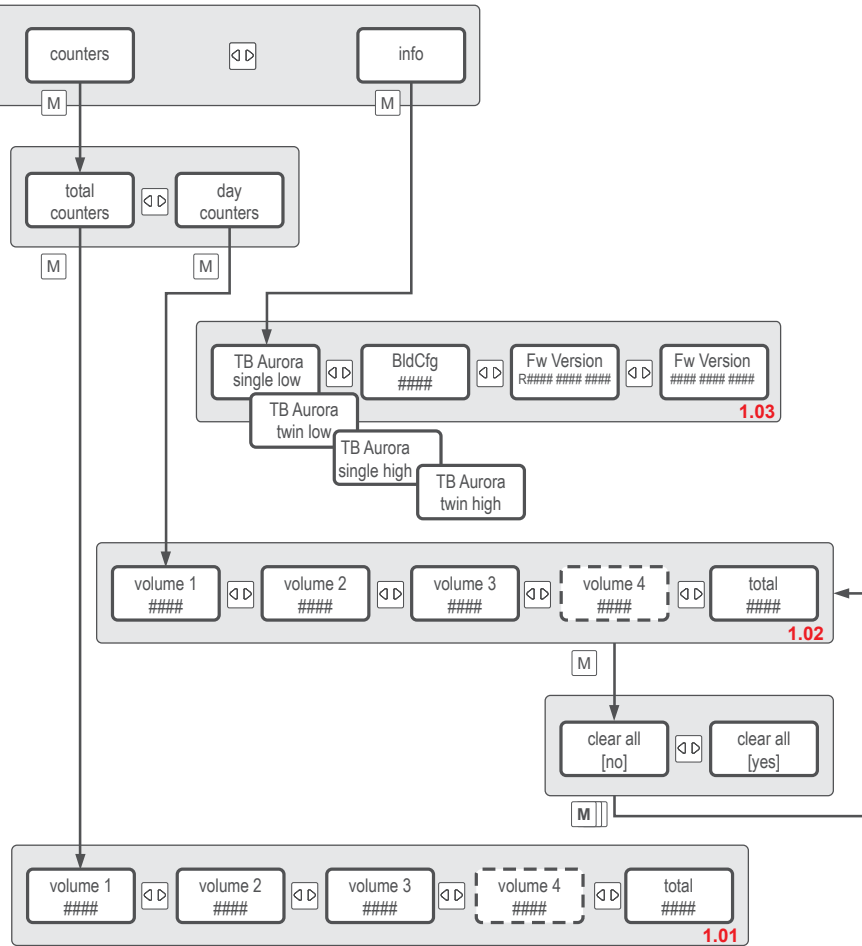
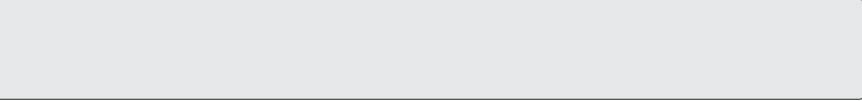

ЭКРАН

С помощью экрана, на который выводятся кнопки и текстовое окно, осуществляется управление работой аппарата.

Текстовое окно

В текстовом окне (1) отображаются:

- меню
- пункты меню
- параметры
- команды
- автоматические процедуры

При использовании аппарата модели Twin черная стрелка (2) указывает на использование левой или правой кофеварки.

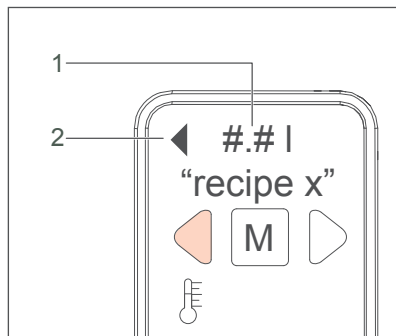

Кнопки

С помощью кнопок выполняется навигация по пунктам меню аппарата.

1. Кнопка МЕНЮ
2. Кнопка ВЛЕВО/ВПРАВО
3. Кнопка ОБЪЕМ
4. НАЧАТЬ/ОСТАНОВИТЬ

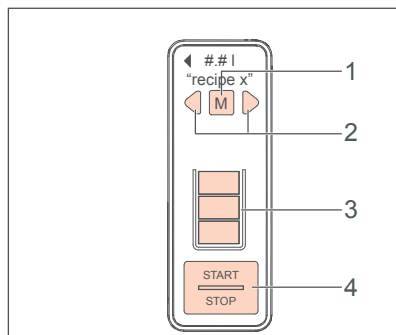

Меню

При обычной работе меню нужны для:

- выбора рецепта
- изменения объема варимого кофе
- пуска или остановка аппарата

В меню для оператора можно выполнить настройку предпочтений.

Действия, выполняемые в меню:

- создание, изменение, скачивание или загрузка рецептов
- изменение параметров температуры, календаря, времени, аппаратов
- изменение параметров программ работы аппарата, таких как:
 - Эко
 - Фильтр воды
 - Удаление накипи
 - Очистка

Навигация

Навигация выполняется нажатием кнопок.

В руководстве приводятся два способа нажатия кнопок:

- Нажать кнопку: быстрое нажатие кнопки.
- Удерживать кнопку: удержание кнопки нажатой в течение не менее 1 секунды.

Использование разных способов нажатия кнопки приводит к выполнению различных действий при навигации по экрану.

Команды кнопок

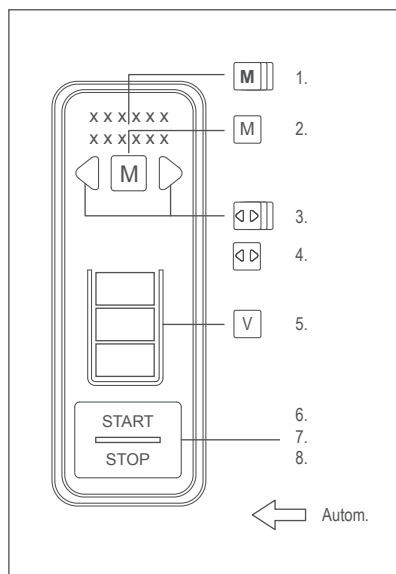

1. Удерживайте кнопку МЕНЮ в течение 1 секунды для подтверждения выбора на уровне меню.
2. Нажмите кнопку МЕНЮ для перехода на следующий уровень меню.
3. Удерживайте кнопку ВЛЕВО/ВПРАВО для выбора другой кофеварки (только в модели Twin).
4. Нажмите кнопку ВЛЕВО/ВПРАВО для прокрутки параметров на уровне меню.
5. Нажмите кнопку ОБЪЕМ для выбора варимого объема.
6. Удерживайте кнопку НАЧАТЬ/ОСТАНОВИТЬ для начала варки.
7. Удерживайте или нажмите кнопку НАЧАТЬ/ОСТАНОВИТЬ для остановки процедуры варки.
8. Нажмите кнопку НАЧАТЬ/ОСТАНОВИТЬ для перехода на предыдущий уровень меню.

Автоматические процедуры

Белыми стрелками на схеме показаны выполняемые аппаратом автоматические процедуры.

RU

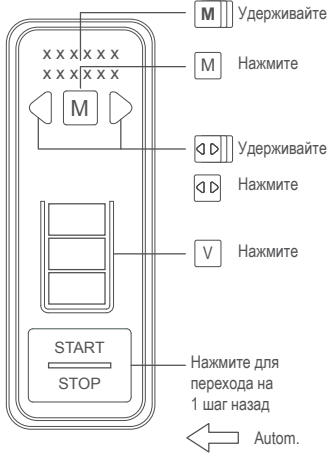

- Модели Twin
- Не обязательно или только для моделей Low
- ” xx ” Постоянное значение
- [xx] Это значение можно изменить

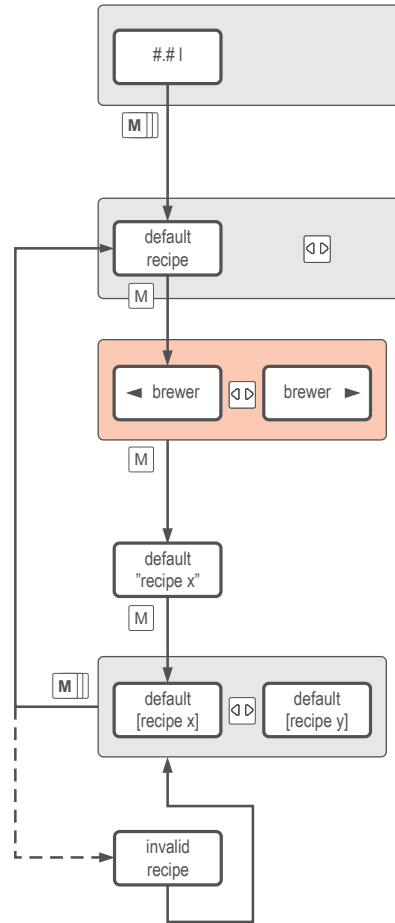

1 Пользовательское меню

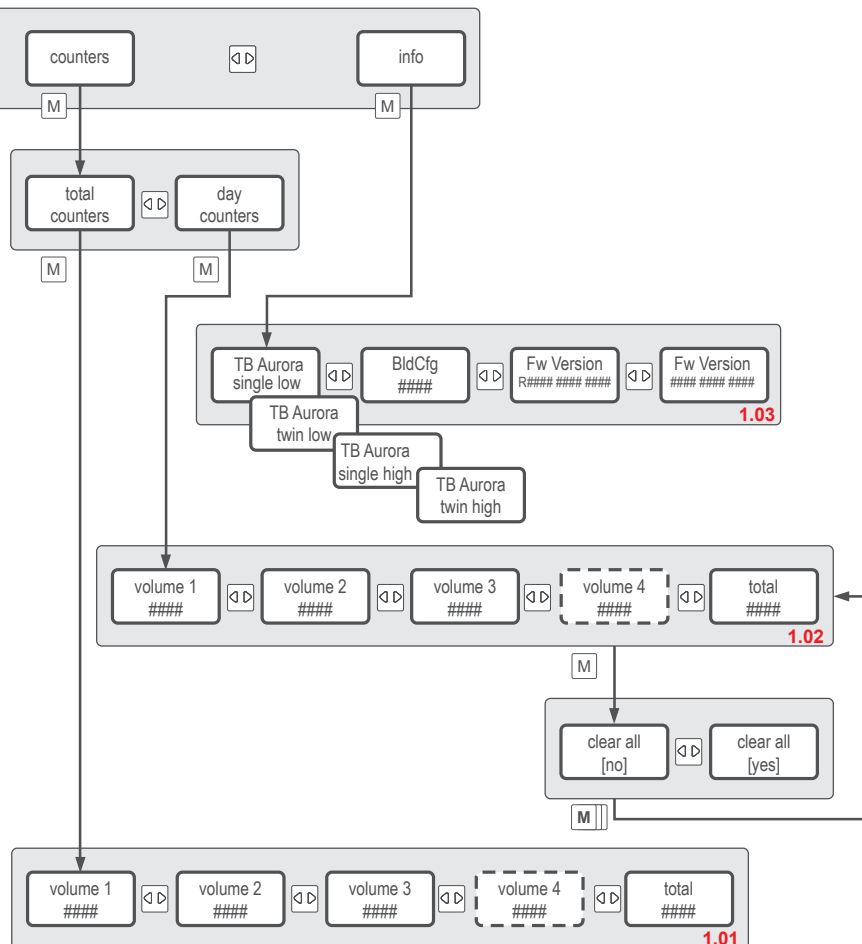

KO

DISPLAY(디스플레이)

디스플레이의 버튼이나 텍스트 창은 머신을 조작하는 데 도움이 됩니다.

텍스트 창

텍스트 창(1)에는 다음 항목이 표시됩니다:

- 메뉴
- 메뉴의 각 항목
- 설정 내용
- 명령
- 자동 절차

트윈 머신일 경우 검은색 화살표(2)는 왼쪽과 오른쪽 중에서 작동시킬 브루어를 가리킵니다.

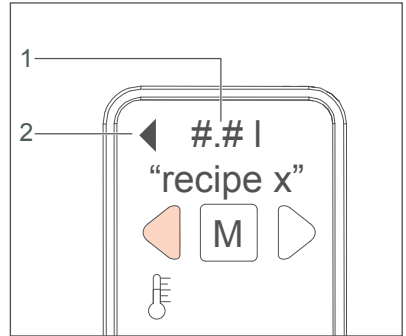

버튼

버튼을 이용해서 머신의 메뉴를 찾아볼 수 있습니다.

1. MENU(메뉴) 버튼
2. LEFT/RIGHT(좌/우) 버튼
3. VOLUME(양) 버튼
4. START/STOP(시작/정지) 버튼

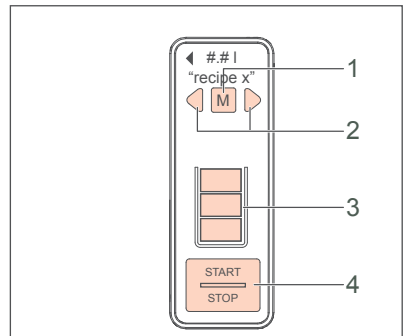

메뉴

메뉴의 기본 작동은 다음과 같습니다:

- 레시피 선택
- 끓일 커피의 양 변경 방법
- 머신 작동 시작 또는 중지

사용자 메뉴에서 사용자의 선택 사항을 정의할 수 있습니다. 메뉴에서 다음을 할 수 있습니다:

- 레시피 만들기, 변경, 다운로드 또는 업로드
- 온도, 일정, 시간, 머신 설정 변경
- 다음과 같은 머신 프로그램 설정 변경:
 - 절전
 - 급수 필터
 - 물때 제거
 - 세척

탐색

버튼을 눌러서 탐색합니다.

본 설명서에는 버튼을 터치하는 다음과 같은 두가지 방법이 나와있습니다:

- • 버튼 누르기: 버튼을 가볍게 터치하기만 하면 됩니다.
 - • 버튼을 누르고 있기: 적어도 1초 이상 버튼을 누른 채로 있습니다.
- 버튼을 터치하는 방법에 따라 디스플레이 탐색 결과가 달라집니다.

버튼 명령

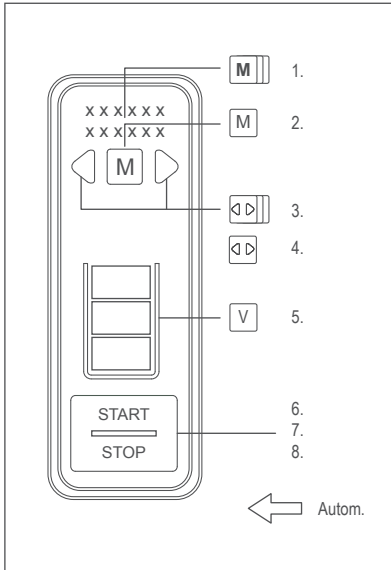

1. MENU(메뉴) 버튼을 1초 동안 누른 채 있으면 메뉴 레벨에서의 선택을 확인할 수 있습니다.
2. MENU(메뉴) 버튼을 가볍게 누르면 다음 메뉴 레벨로 넘어갈 수 있습니다.
3. LEFT/RIGHT(좌/우) 버튼을 누른 채 있으면 양쪽 브루어 간에 전환할 수 있습니다 (트윈 버전만 해당).
4. LEFT/RIGHT(좌/우) 버튼을 가볍게 누르면 메뉴 레벨의 옵션을 스크롤할 수 있습니다.
5. VOLUME(양) 버튼을 가볍게 누르면 끓일 양을 변경할 수 있습니다.
6. START/STOP(시작/정지) 버튼을 누른 채 있으면 끓이기 과정이 시작됩니다.
7. START/STOP(시작/정지) 버튼을 누르거나 누른 채 있으면 끓이기 과정이 취소됩니다.
8. START/STOP(시작/정지) 버튼을 가볍게 누르면 이전 메뉴 레벨로 돌아갑니다.

자동 절차

구성표에 있는 흰색 화살표는 머신에 의해 진행되는 자동 끓기 절차를 가리킵니다.

KO

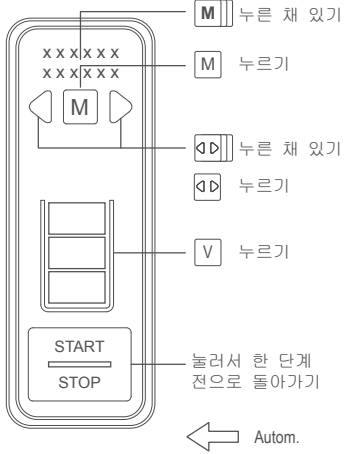

트윈 버전

옵션 또는 하위 버전 전용

”xx” 고정값

[xx] 이 값을 변경할 수 있습니다

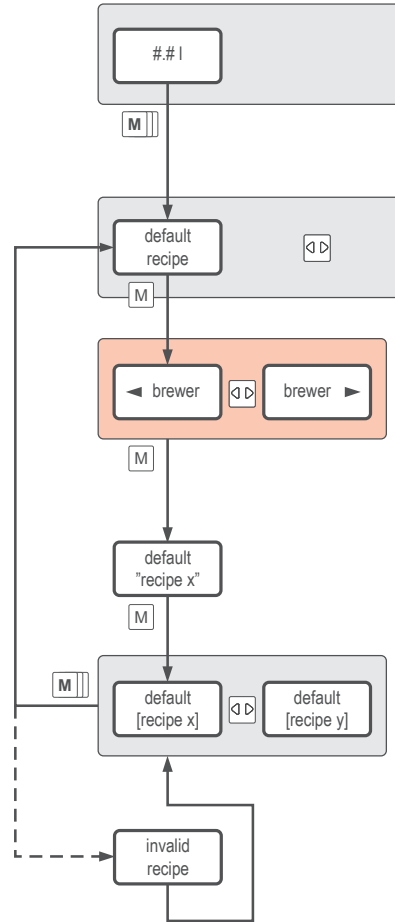

1 사용자 메뉴

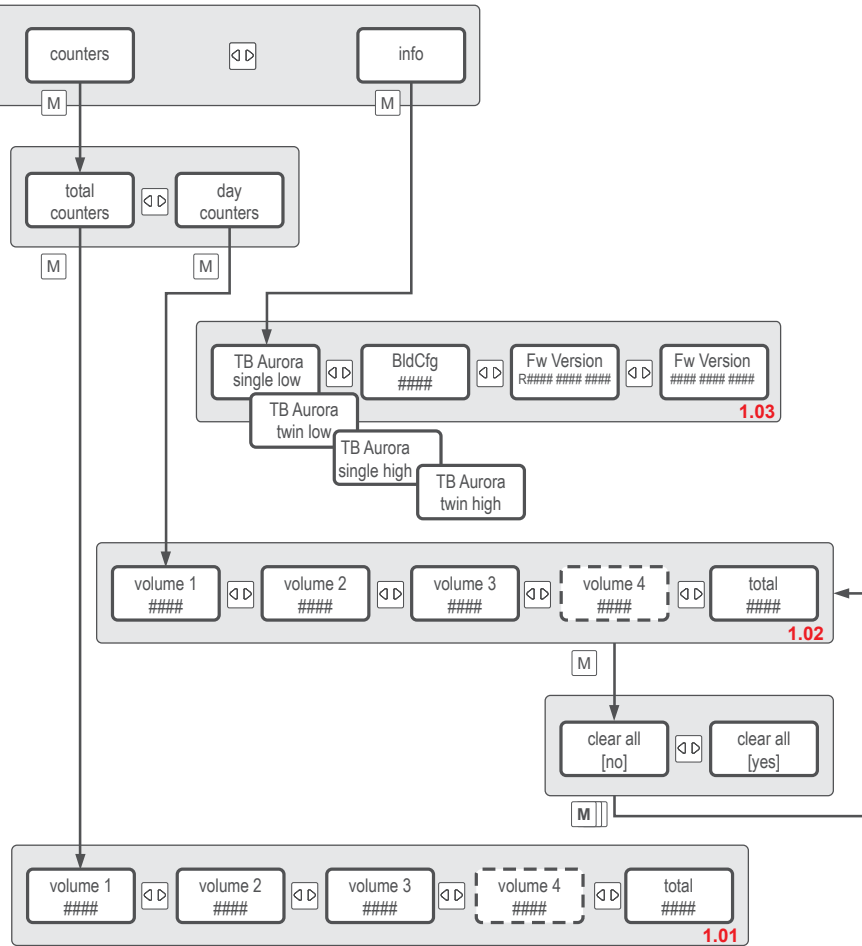
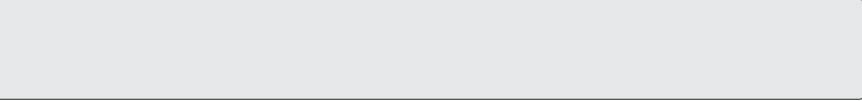

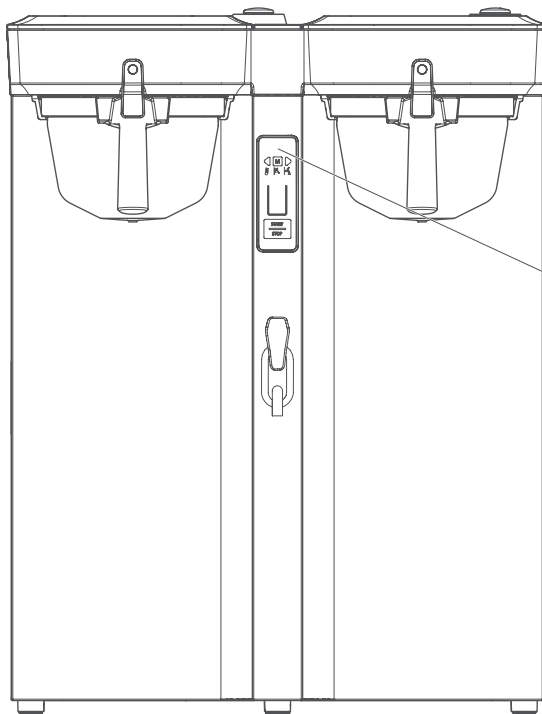
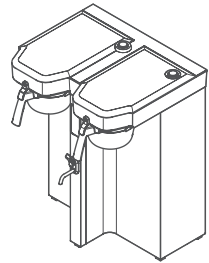
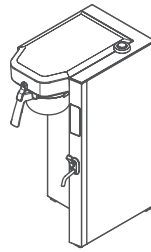
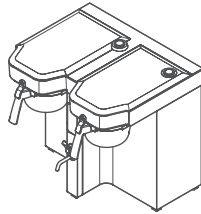
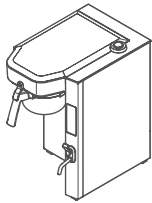

E

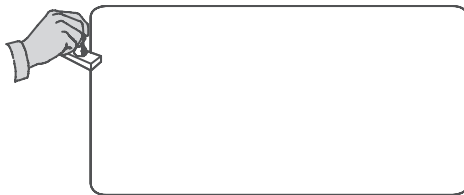
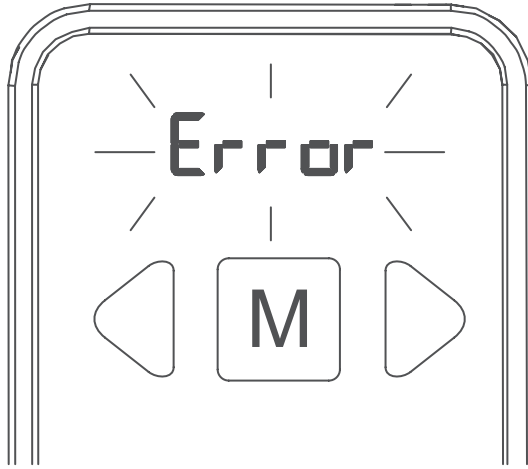



**/// BRAVILOR
BONAMAT**

© 02 - 2022

VHH

